

JOB NAME: \_\_\_\_\_ DATE: \_\_\_\_\_

DOOR LOCATION: \_\_\_\_\_ DOOR NO: \_\_\_\_\_ SHEET OF \_\_\_\_\_

## RADIO CONTROLS 300 Mhz

RECEIVER UNIT FOR  
 ALL RADIO CONTROLS

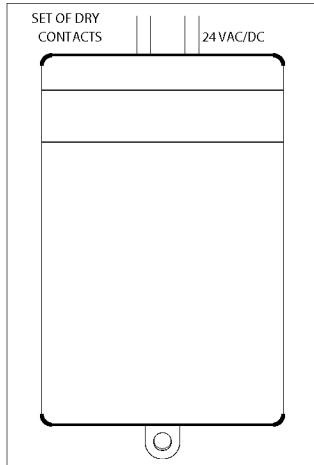

Note: 4 Wires shown.

BATTERIES REQUIRED

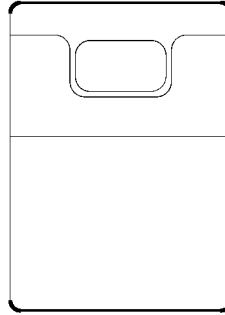

SINGLE CHANNEL  
 TRANSMITTER

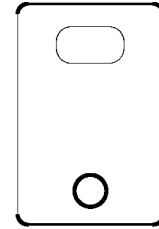

SINGLE CHANNEL  
 MICRO TRANSMITTER

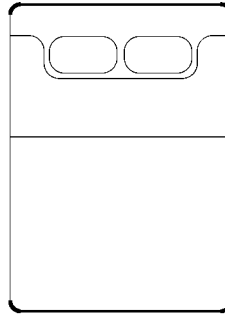

DUAL CHANNEL  
 TRANSMITTER

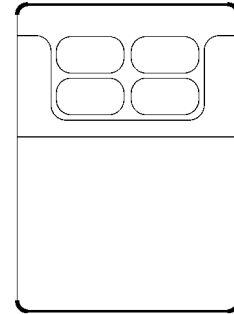

FOUR CHANNEL  
 TRANSMITTER

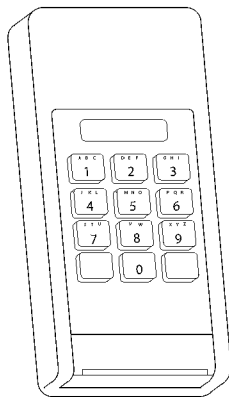

WIRELESS  
 KEYLESS  
 TRANSMITTER

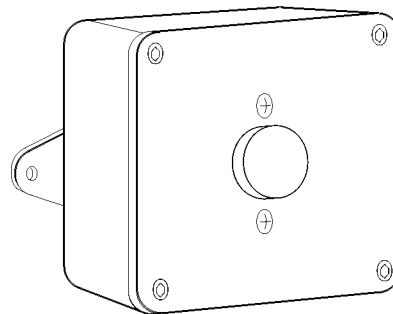

PUSH BUTTON  
 RADIO  
 CONTROL