

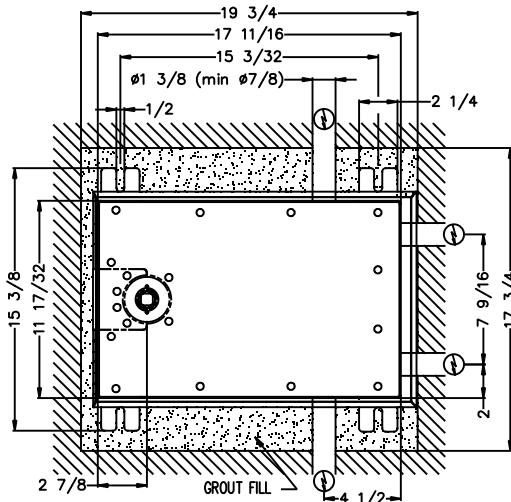

**MOTION® TN 110 IN-FLOOR SWING DOOR OPERATOR
FLUSH MOUNT BOX**
SINGLE DOOR LH INSWING CENTER PIVOT w/ BREAKAWAY APPLICATION

JOB NAME: _____ DATE: _____
DOOR LOCATION: _____ DOOR NO: _____ SHEET ____ OF ____

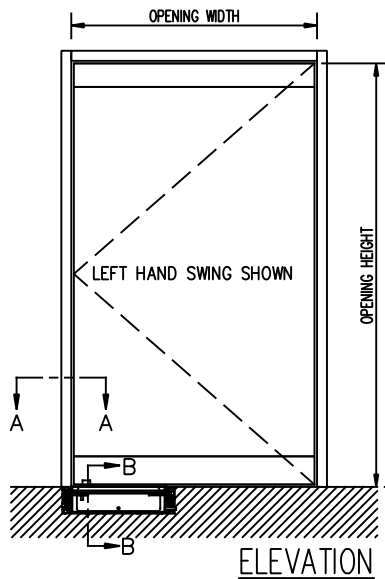

**OPERATOR AND FLOOR BOX
TOP VIEW**

- OPTION B**
- EXTENDED SHAFT
 - SPECIAL REMOVABLE COVER BOX FOR FLOOR COVERING INSTALLATION
 - MAX. FLOOR COVERING = 1/2"
- PIT DIMENSION**
19 3/4"L x 17 3/4"W x 6 7/8"D

FLOOR BOX - OPTION B

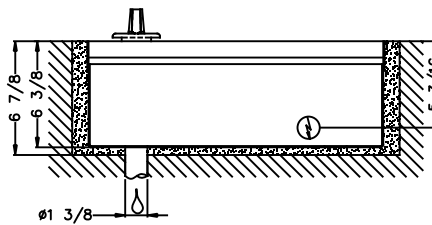
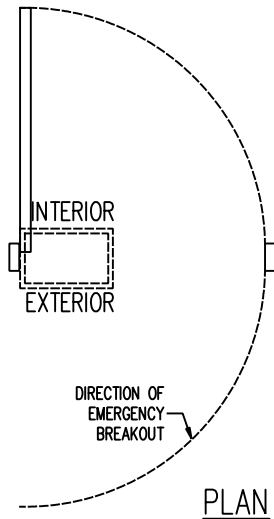

FRONT SECTION

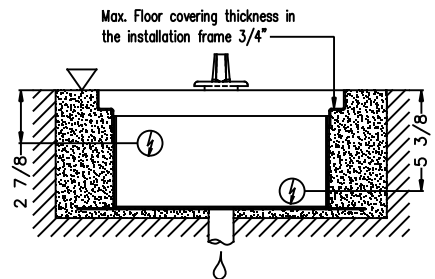

END SECTION B-B

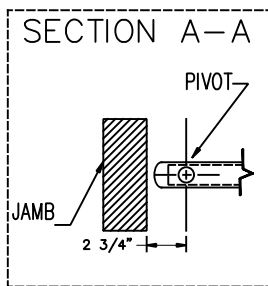

CENTER PIVOT

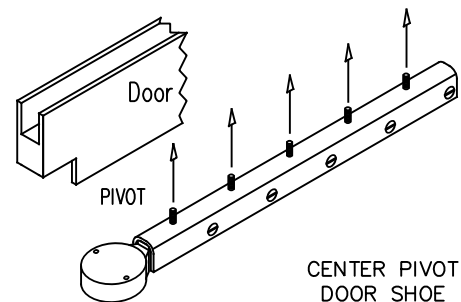

**CENTER PIVOT
DOOR SHOE**

REFER TO THRESHOLD DETAIL DRAWING FOR DISTANCE FROM BOTTOM OF DOOR SHOE TO FINISHED FLOOR

- ▽ Concrete or Finished Floor
- ⚡ Weep Drain Required
- ⚡ Possible Electrical Feed

NOTES:

1. DETAILS NOT TO SCALE.
2. ELECTRICAL REQUIREMENTS:
120VAC, 15AMP MIN. TO EACH CONTROLLER LOCATED REMOTE FROM OPERATOR. LOW VOLTAGE CONDUIT RUN FROM EACH CONTROLLER TO OPERATOR BY ELECTRICAL CONTRACTOR.
3. DOORS, FRAMES AND HARDWARE BY OTHERS.
4. 32" CLEAR DOOR OPENING REQUIRED TO MEET A.D.A. REQUIREMENTS.
5. DOORS MUST BE NON-LATCHED FOR PROPER OPERATION.
6. OPERATOR CAN BE CONFIGURED TO MEET ANSI STANDARDS A156.10 & ANSI A156.19